

## TABLE OF CONTENTS

<b>Sr No</b>	<b>Contents</b>	<b>Page No.</b>
1.	Basic textile terms	1
2.	Weaving	1
3.	Sequence of operations in weaving	2
4.	Identification of parts	3
5.	Motions of loom	5
6.	Weavers knot	13
7.	Fabric defects	15
8.	Loom patrolling	18
9.	Patrol control	20
10.	Contingencies	22
11.	Instructions for shift change	23

## 1. BASIC TEXTILES TERMS:

- **Yarn:** A continuous strand of fibers/filament, twisted /non twisted, it is basic raw material for weaving.
- **Type of Yarns:** single yarn, double or multi fold yarn, spun yarn & filament yarn etc.
- **Yarn count:**
  - Yarn count is the numerical expression of yarn, which defines its fineness or coarseness. (Linear density).
  - Yarn count system:
    - Indirect system: English count (Ne), Worsted Count etc.
    - i.e. Higher the yarn number, finer the yarn.
    - Direct System: Tex, Denier
    - i.e. Higher the yarn number , Coarser the yarn.
    - Similarly numerical expression of fineness or coarseness of sliver & roving are called Hank.
    - Note: English (Ne) count system is commonly followed India.
    - English Count: No. of Hanks of length 840 yds weighing in 1 pound
    - 1yds: 0.9144mtrs
    - 1lbs: 0.453 Kgs.
    - e.g.  $40^s Ne = 40$  hanks of 840 yds weighs 1 lbs.
    - $20^s Ne = 20$  hanks of 840 yds weighs 1 lbs.

## 2. WEAVING:

- **Weaving** is a process of fabric production in which two distinct sets of yarns are interlaced at right angles to each other to form a fabric or cloth.
- The lengthwise yarns are called the warp yarn and the widthwise yarns are called the weft yarn.
- **Selvedge:** The length wise running edges of woven fabric are known as selvages. It prevents unraveling of warp yarns.

➤ **Sequence of operations in weaving ( shuttle loom)**

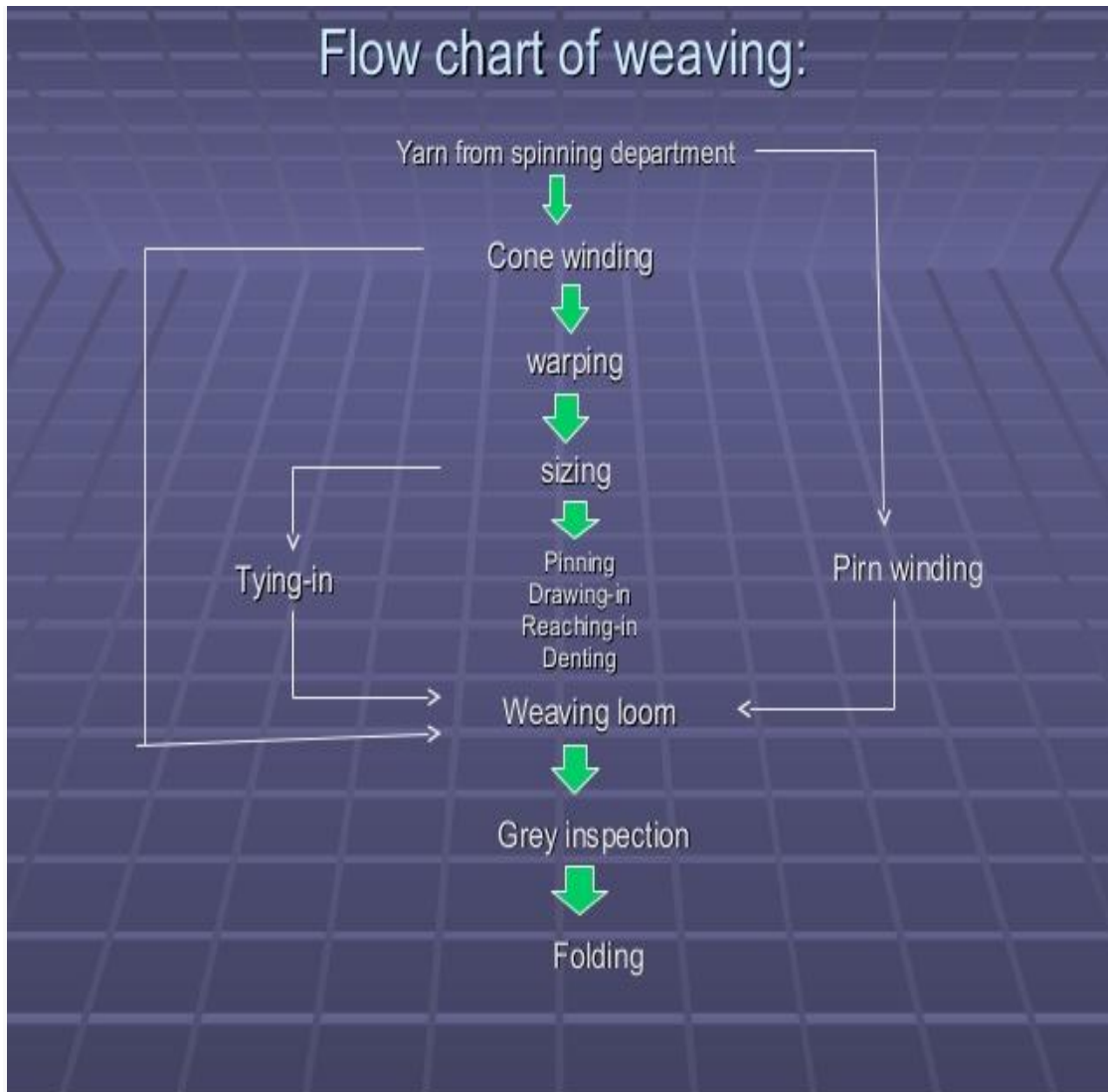

### 3. IDENTIFICATION OF SHUTTLE LOOM PARTS:

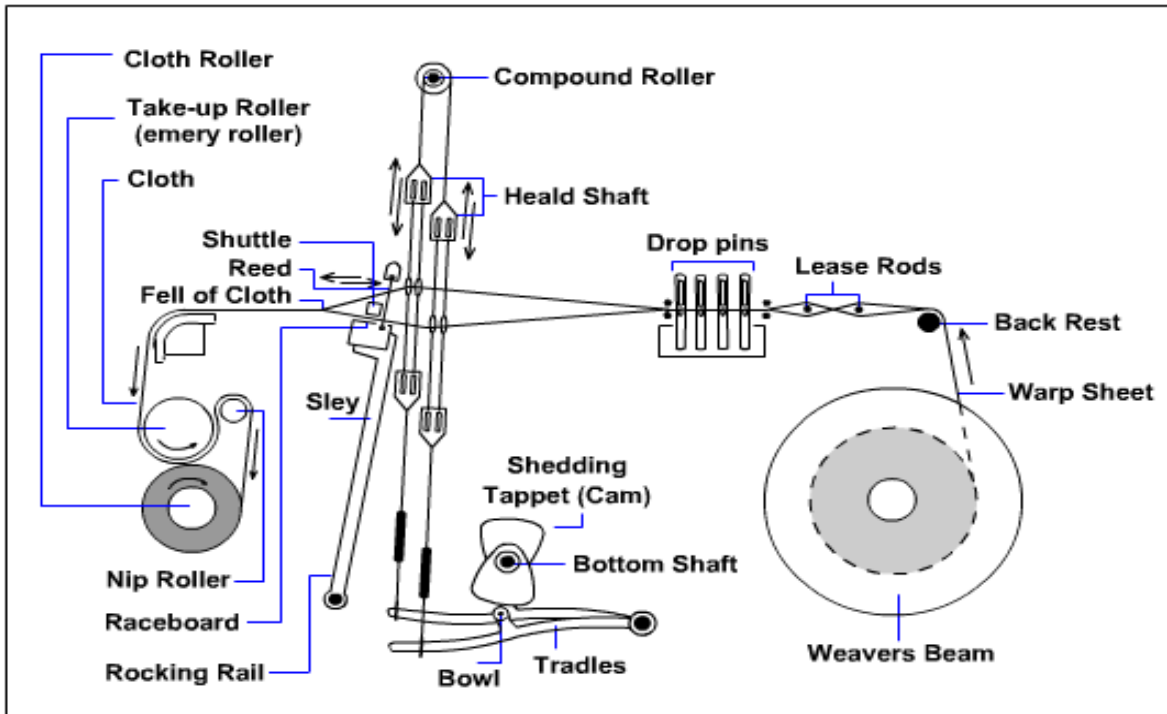

#### Major Parts of Loom:

**Weaver's beam:** The weaver's beam which consists of the lengthwise yarns is located at the back of the loom & it releases the warp yarn to the weaving area of the loom as needed.



**Heald Frame:** it is a frame to hold the heald wires. Heald wire it is a wire with a hole or eye in its centre through which a warp yarn is threaded.

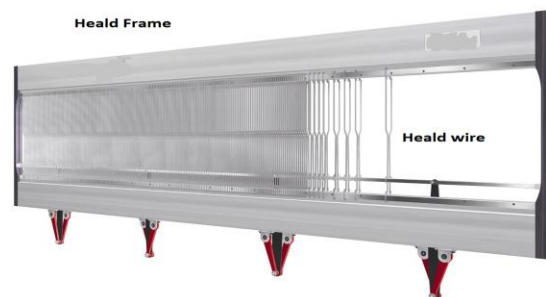

**Bobbin and Shuttle:** The weft yarn wound on a bobbin (pirn), which sets into a shuttle. As the shuttle passes back and forth through the warp shed, it releases weft yarn from the pirn.



**Reed:** This is inevitably a combination made up of steel wires set vertically in a frame. The spaces between the wires are known as dents.



**Temples:** They divide at the edges of the cloth which supports to maintain fixed dimension in width.



**Cloth roller:** It is located at the front of the loom, hold the completed fabric

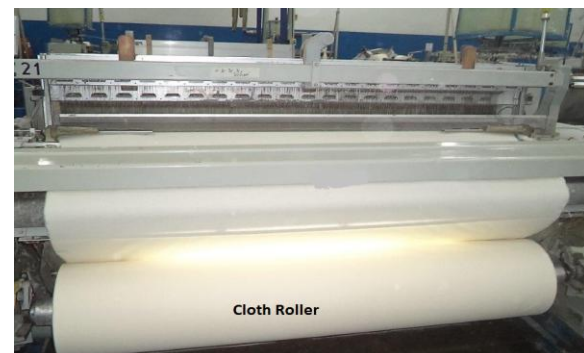

## MOTIONS OF LOOM:

### Primary motions:

#### Shedding motion:

Shedding separates the warp yarns into two layers for the insertion of a pick. The function of shedding mechanism is to raise & lower the heald frames. Which carry a group warp ends drawn through heald eye. There are three kinds of shedding mechanism namely Tappet, Dobby & Jacquard.

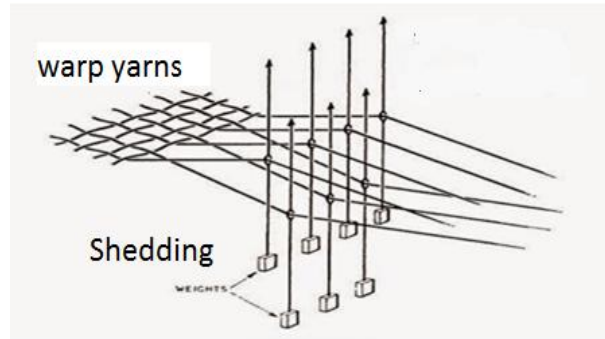

#### Picking motion:

Picking motion inserts a pick (weft) from one side to the other side of the fabric.

In **conventional** looms, pick is inserted with the help of a shuttle through the shed opened by the shedding mechanism. i.e. between the two layers of warp shed.

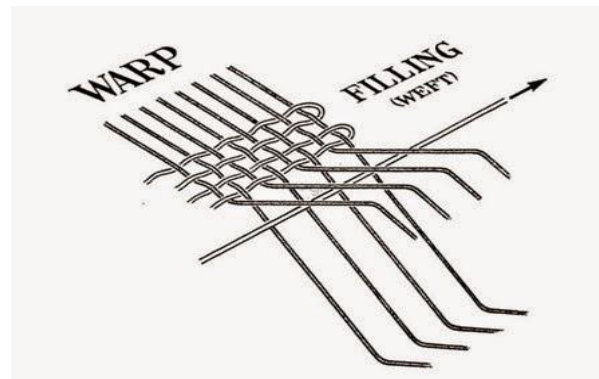

#### Beating-up:

The function of beat up mechanism is to push the weft thread that has been inserted across the warp threads in a shed, up to the fell of cloth. Fell of the cloth is the position of the last pick in cloth woven on the loom. The beating-up of the weft to the fell of cloth is carried out by the reed, which is fixed on the sley by means of a reed cap.

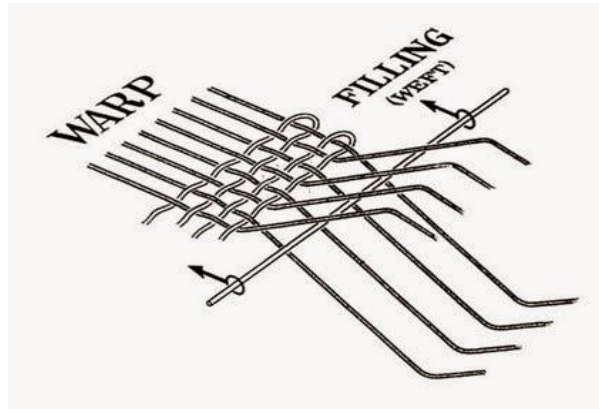



## Secondary motions:

### Take-up motion :

Take-up motion winds the fabric as being manufactured.

It means after the beat up of the weft, woven cloth is drawn away from the reed at the regular rate with the help of emery roller and this rate is decided by the number of picks (picks per inch / picks per 10 centimetre).

In conventional looms a set of seven / five gear wheels and a ratchet wheel are used.

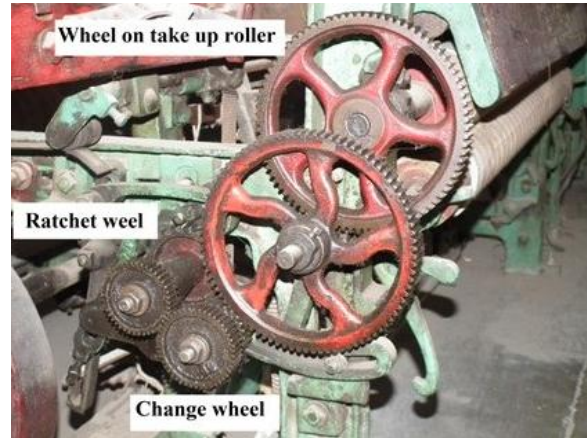

### Let-off motion

Let-off controls the amounts of warp delivered and maintained the regional tension during weaving. It is classified as Negative/Semi Positive let off.

This motion delivers warp to weaving area at the required rate and at a suitable constant tension by unwinding it from a flanged tube known as the weaver's beam

Let-off (warp control) controls the amounts of warp delivered and maintain the regional tension of the warp during weaving.

The weaver has to manually adjust the weight on the tension lever to maintain the tension of warp sheet.

In semi positive let-off motions the attention of weaver to adjust the tension of the warp sheet is reduced to the large extent as the mechanism itself takes care of it.

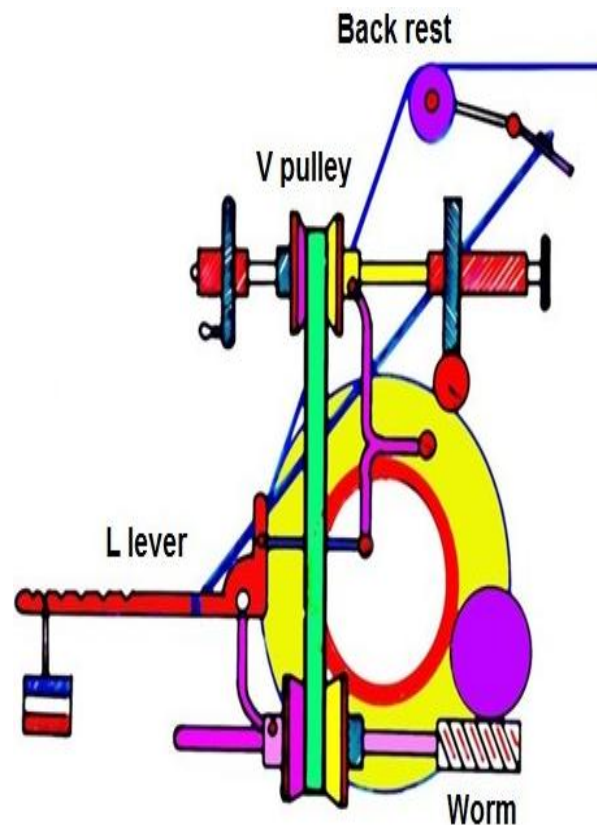

### Auxiliary motions:

#### Warp stop motion

To stop the machine even when a single warp breaks and to facilitate detection of broken end. Warp stop motion detect warp (End) breaks and stop the loom preventing missing end in the cloth.

There are two types of warp stop motions in use i.e. Mechanical & Electrical / Electronic.

Each & every warp ends are drawn through an independent **drop pin**, which are suspended, on the warp yarn.

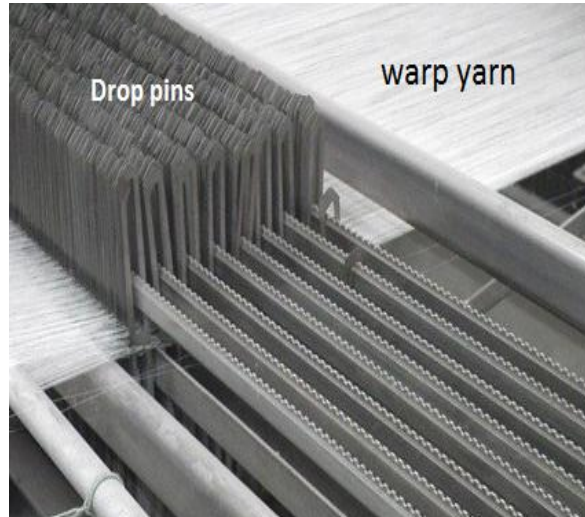

#### Weft stop motion:

Weft stop motion detects the presence of weft yarn. In absence of weft yarn it stops the loom.

In conventional loom it is known as weft fork stop motion where a fork feels the presence of weft yarn and in absence of weft yarn, loom stops.

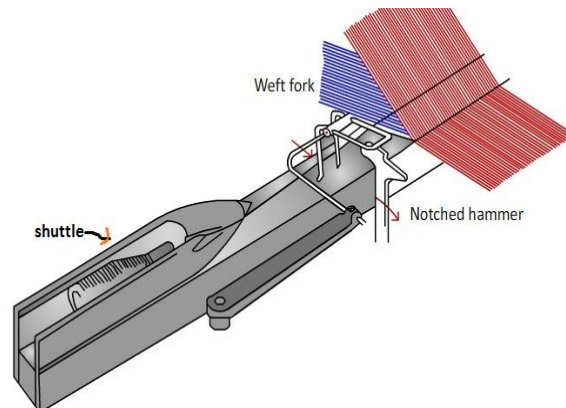

#### Reed Protection motions:

There are two-type of safety motions (i) Loose reed & (ii) Fast reed.

It prevents massive breakage of a large number of threads when a shuttle is trapped in the shed.

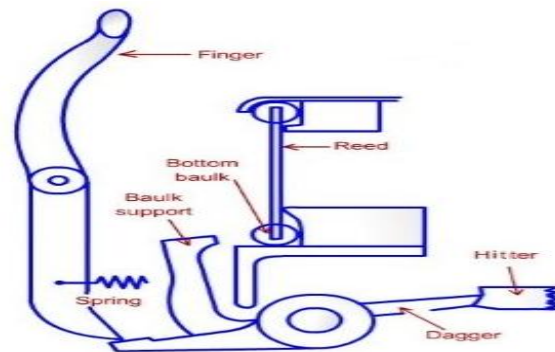

#### Pick finding motion:

This motion stops the loom in the exact shed where the pick is not inserted or broken. Weaver can repair the broken weft and start the loom without causing a thick/thin place/double pick



### **Anti-crack motion:**

This motion prevents cracks & starting marks on the fabric, whenever there is a weft break. Fell of the cloth goes back by 1- 2 picks, which prevents a thin place

### **Brake mechanism:**

This motion stops the loom instantaneously as and when there is an indication of warp or weft break by warp/weft stop motions.

## **4. Operations for Automatic Shuttle Loom**

### ➤ **Attending to Warp Break:**

- find out broken warp ends
- Find out the location of the broken end, by bringing the hands under the dropper bars, with mechanical droppers.
- detect the location using the indication lamp & by bringing the hands over the droppers, with electrical warp stop motion
- mend the broken warp end in the sized beams with the thrums of the same count of the sized beams, using " weavers ' knots"
- draw the mended warp yarn through the healds properly ,as per the drawing order prescribed
- Draw the mended warp yarn through the reed dent, properly, as per the denting order prescribed.
- See that the sley has been brought to the back centre.
- See that the shuttle is inserted fully in the shuttle box.
- Run the loom by pulling the starting handle with full torque.



**warp yarn break**



**weaver detects warp end**



**weaver pick broken end**



**put the weavers knot**



**weaver braw broken end  
through heald eye**



**end draw through reed**



**mend the end & start  
the loom**



➤ **Attending to Weft Break:**

- see that the sley has to be brought the back centre
- take out shuttle from shuttle box
- do pick finding
- find out the last pick inserted in the produced cloth
- tie sley to the back centre, after doing the pick finding
- insert shuttle into the correct box as per the pick finding done
- see that the shuttle is inserted fully in the shuttle box
- Bring the loom to the front centre to see that there is no gap between the reed & the fell of the cloth. accordingly take up should be adjusted
- bring back sley to centre
- see that the shuttle is inserted fully in the shuttle box
- run the loom by pulling the starting handle with full torque

**CHANGING PIRN IN THE SHUTTLE / MENDING WEFT BREAK**





➤ **Battery Filling:**

- pull about 2 mtrs of weft in the pirns in the right hand & hold around 4 - 5 pirns at a time in the left hand
- Press the pirn head of the pirns in space in the battery disc one by one and press the tips of the pirns in the aligned path of the pirn holders, then wind the pirn threads in the battery umbrella, anti clock wise.

➤ **Other Work Practices:**

- Correct the fabric defects like wrong drawing, wrong denting, end out, double end etc., immediately and also ensure that the other fabric defects too are corrected at the earliest, before continuing further production.
- clean the machines & work area, so as to ensure good working atmosphere, without damaging the fabrics in the looms where the cleaning work is carried out as well as in the adjacent & opposite looms . Should not misuse "air". can use air for cleaning, only in the areas, where it is allowed
- " not woven " the same in case of any floats
- run the machine without " starting mark or crack"

- Ensure that the loose threads are hanged in higher length (not more than 4 mm). Accordingly, and trimmed, after attending to the warp breaks.
- patrol the machines and do mending so as to minimise the stoppages
- Tie the "waist bag" & all the waste generated by the weavers are collected in the said waist bag, which can be ultimately disposed in the places/ bins provided, at the end of the shift.
- ensure that the correct weft yarn, as per the "loom card" only is used
- See that the weft yarn is completely used, without giving room for additional wastage of raw materials. For any quality issue or defective cone etc., the same has to be brought to the notice of the supervisors.
- Avoid pulling out warp ends unnecessarily. if end is getting cut often in the selvedge , the same has to be brought to the notice of the mechanics/ fitters/ supervisors & get it corrected
- ensure that all the stop motions, preventive mechanisms etc., function properly
- ensure correct quality of thrums are there & see that the same are properly tied
- check the knotted loom for knotting quality etc. double ends have to be removed should report to supervisors for any deviation in the same & for any other quality issue
- ensure that his/ her looms are stopped for a minimum possible down time due to whatever reason & see that he/ she gets maximum outputs in his/ her shift
- check the fabrics for the defects at least twice in a shift and sign on the cloth in both times
- ensure that cloth rolls are doffed whenever/ wherever necessary
- Give preference to safety. Should not enter the area, where he/ she is not allowed. should not do a job in which training has not being given
- Ensure that no raw material/ cloth/ spare/ tool / any other material is thrown under/ near the machines or in the other work areas.
- Check for the reasons for the frequent warp/ weft breaks. The reasons that could be corrected by himself/ herself should be corrected. otherwise, the same has to be reported to the mechanics/ fitters/ supervisors.



## 5. WEAVERS KNOT

The following illustration explains the procedure for putting weavers knot.

1.

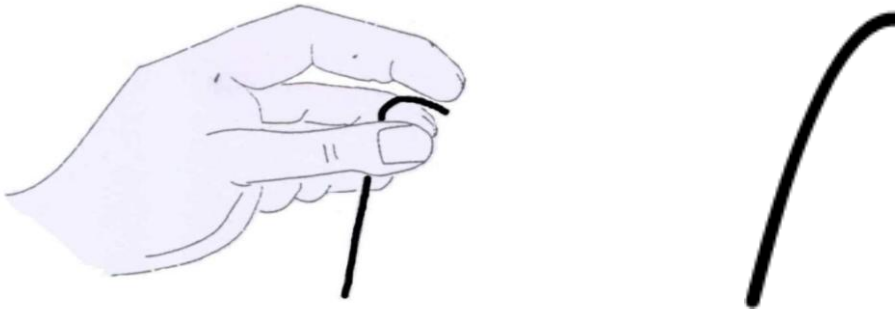

Pick up the broken end 6 mm from its end with the left hand thumb and second (middle) finger.

2.

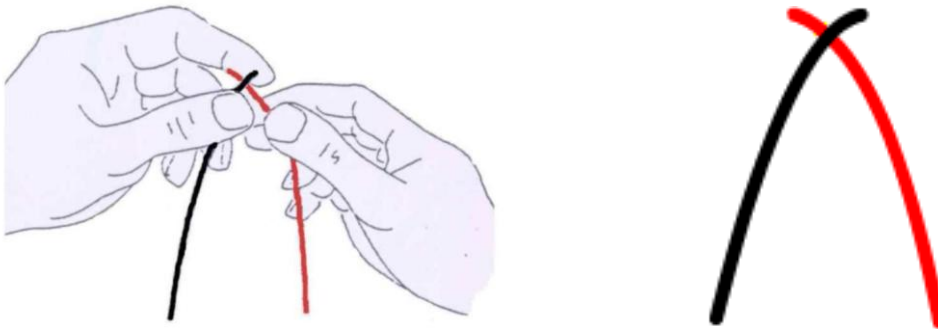

Then tie thread is then placed under the broken end by the right hand.

3.

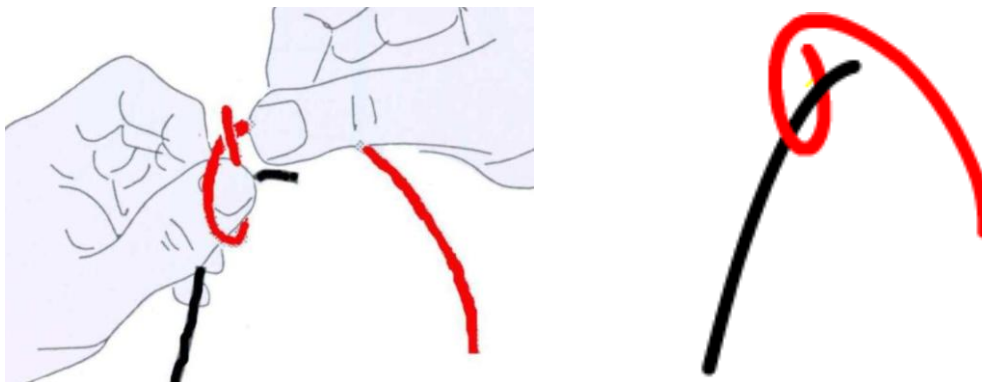

A loop is made with the tie thread around the left hand thumb, and tie thread passed behind the tie thread end.



4.

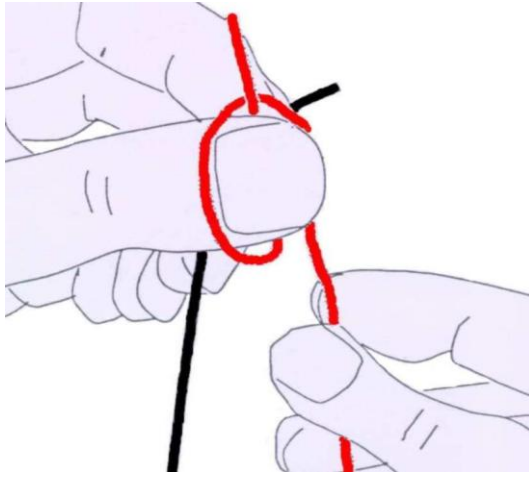

The first finger of the left hand is moved down against the thumb to hold the loop in position on the thumb.

5.

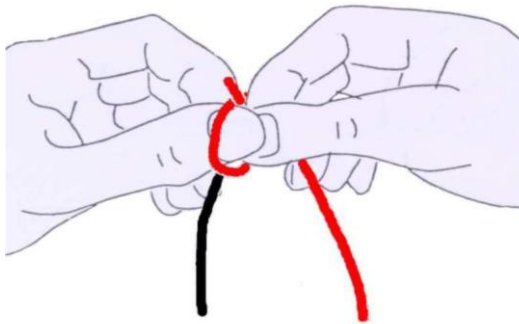

Right hand thumb is used to push the tail formed by the broken end, under the left hand thumb.

6.

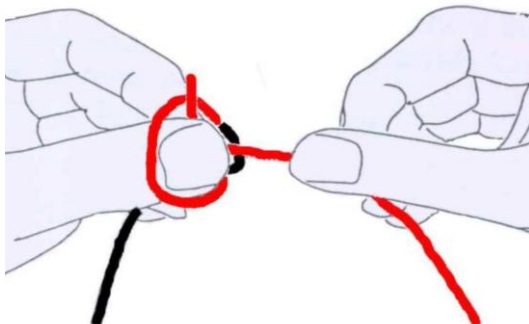

To form the knot, the right hand pulls the tie thread, while the left hand holds the knot stationary. They should be no pulling by the left hand.

7.

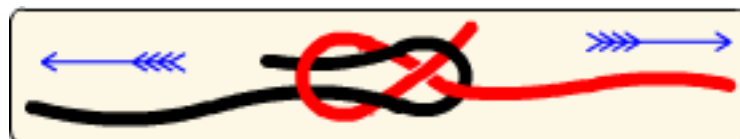

## 6. FABRIC DEFECTS:

Defect is an unwanted structure on the fabric due to many reasons. The following are the some of the type of the fabric defects e.g. missing ends, missing picks, reed mark, double end, weft crack, weft bar, temple mark, starting mark, float, slubs etc

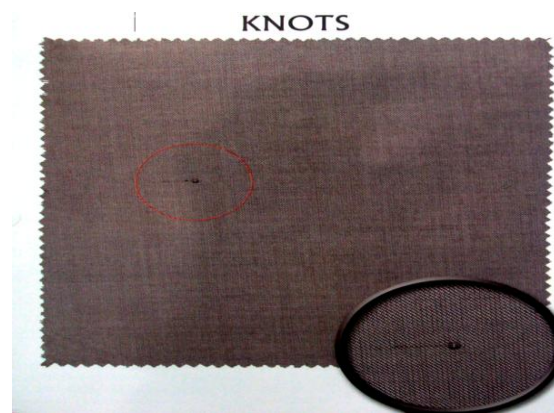
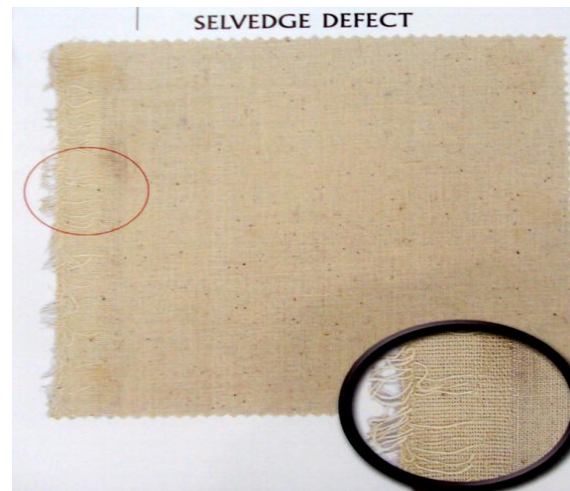
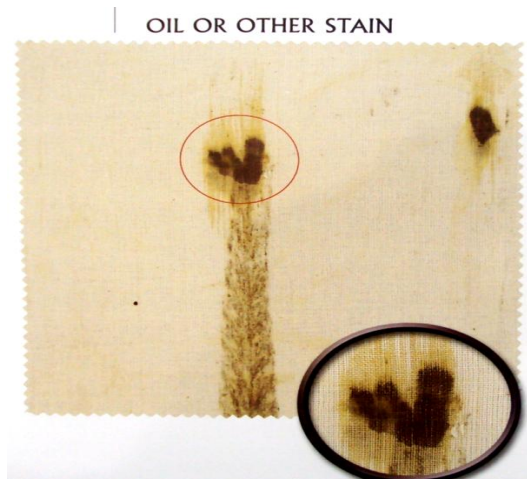
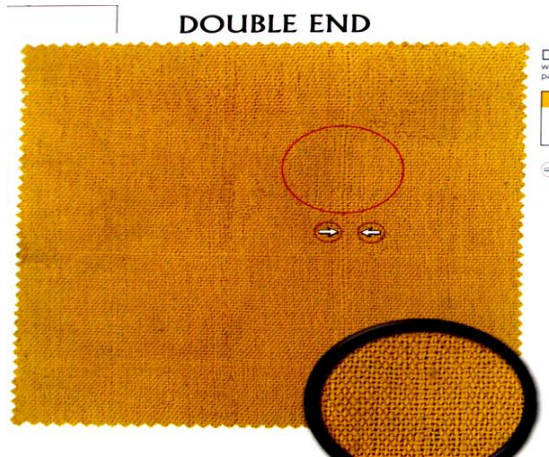

### Fabric Defect Tables

<b>Name</b>	<b>Appearance</b>	<b>Cause</b>	<b>Action</b>	<b>Prevention</b>
Thick Place in weft Direction.	Bars of denser woven fabric across cloth	Faulty let-off or take-up motion.	Inform fitter.	Constant patrol and cloth inspection.
Weaving Without Weft.	Strings of warp yarn only.	1. Faulty weft sensor 2. Electrical fault	Inform fitter.	Constant patrol and cloth inspection.
Slack End.	A warp end gathering in the cloth.	1. End run out on the warp beam. 2. End not in drop wire.	1. Repair broken end. 2. Draw end into drop pin.	Constant patrol and cloth inspection.
End out.	Thin gap in warp	1. Warp stop motion not working. 2. Electrical fault. 3. Fluff build up in drop wires.	Inform fitter.	Constant patrol and cloth inspection
Floating End.	Un-woven warp end	1. End not drawn into heald. 2. Broken heald.	1. Draw end into heald. 2. Replace broken heald.	Constant patrol and cloth inspection
Starting Place.	Light gap weft way in the cloth	1. Incorrect machine setting. 2. Not shed levelling when machine stopped	1. Inform fitter. 2. Inform fitter.	Constant patrol and cloth inspection.
Slubs.	Thick lumps of yarn weft way	1. Faulty weft yarn. 2. Not removing broken weft correctly.	1. Change cone; inform supervisor. 2. Correct weft repair method.	Constant patrol and cloth inspection. Good methods.
Wrong Dent.	thin line warp way in the cloth.	End or ends drawn into the wrong dent.	Re-draw ends in correct dent.	Know correct denting order.
Wrong Draft.	Irregular pattern warp	End or ends drawn into the wrong	Re-draw ends in	Know correct drafting order.

	way in the cloth.	head.	correct head.	
Broken Pick.	Visible line weft way in the cloth.	<ol style="list-style-type: none"> <li>1. Broken weft not completely removed.</li> <li>2. Loose pick not found.</li> <li>3. Faulty weft detector.</li> </ol>	<ol style="list-style-type: none"> <li>1. Check full width of cloth at a weft break repair.</li> <li>2. Always check for the loose pick.</li> <li>3. Inform fitter.</li> </ol>	Always use correct weft repair methods. Constant patrol and cloth inspection.
Thin Place	Light bar across the cloth due to low weft density.	<ol style="list-style-type: none"> <li>1. Faulty let-off or take-up motion.</li> <li>2. Cloth wrapped around rollers.</li> <li>3. Faulty weft yarn.</li> </ol>	Inform fitter.	Constant patrol and cloth inspection.
Double Pick.	Thick line running across the cloth.	<ol style="list-style-type: none"> <li>1. Not having found the losing pick.</li> <li>2. Reserve cone caught and running in.</li> </ol>	<ol style="list-style-type: none"> <li>1. Always find the pick correctly.</li> </ol>	Correct weft repair methods. Correct weft creeling method.
Thick Place weft way	Thick bar in weft way	<ol style="list-style-type: none"> <li>1. Double weft running in.</li> <li>2. Thick/wrong weft yarn.</li> <li>3. Double weft from winding department.</li> </ol>	<ol style="list-style-type: none"> <li>1. Break the second yarn and secure correctly.</li> <li>2. Remove cone inform supervisor.</li> <li>3. Remove cone inform supervisor.</li> </ol>	Correct weft creeling method.
Warp Way Stitching	Unwoven ends warp way in the cloth.	<ol style="list-style-type: none"> <li>1. Fluff or knot behind the reed.</li> <li>2. Spare end weaving in.</li> <li>3. Not removing broken warp end</li> </ol>	<ol style="list-style-type: none"> <li>1. Check and clear fluff or knot from behind reed.</li> <li>2. Remove</li> </ol>	Constant patrol and cloth inspection.  Correct methods for

		from shed. 4. Too long tails on weaver' knot.	spare end. 3. Remove waste yarn from shed. 4. Keep tails to 6 mm on weaver's knot.	weaver's knot and warp break repair.
Tuck in Fault/long tails.	Fringe of tails close to or on the selvedge.	1. Fluff under weft brake. 2. Fluff under weft gripper. 3. Leno ends drawn incorrectly. 4. Weft threading incorrect. 5. Weft cutter not working. 6. Incorrect machine settings.	1. Clear fluff. 2. Clear fluff. 3. Correct leno end drawing. 4. Re-thread weft correctly. 5. Inform fitter. 6. Inform fitter.	

### Remedial measures for controlling the defects

Defects can be reduced by using good quality of yarn, good weaving preparations; proper loom settings at various stages of fabric manufacturing & continuous loom patrolling.

## 7. LOOM PATROLLING

### Cycle Patrolling:

- It consists of starting at a given machine and proceeding around the whole set in a regular and consistent manner.
- The purpose of this is to inspect and correct everything that would cause a stop of the machine, before it happens.
- This way of patrolling is especially used for high quality fabrics, or for high warp breaks, for looms without stop signalling, or for high number of looms in a section.





## 8. PATROL CONTROL

### Back of Loom (Warp Alley)

- **Slubs:**

A thick place in the warp: slubs in the warp yarn sheet can cause problems when passing through the drop wires, heald wires or reed. Once spotted it is the weaver's responsibility to remove it, to avoid warp breaks if the slub does not pass the reed; or to avoid a fault if the slub goes into the cloth.
- **Extra end:**

Guide it through the guide eyes to the winding device.
- **Missing end:**

Take the nearest positioned extra end and guide it through the guide eyes to the missing end position.
- **Crossed end:**

To be corrected by the weaver.
- **Lap end on warp beam:**

It can be an extra end coming up, or a previously missing end coming back.
- **Thick end or wrong yarn count (Ne):**

Take out, guide to the winding device, identify the end as incorrect with a label, and replace with a normal end from the extra end reserve.
- **Stuck ends / sizing fault:**

Separate the ends with the help of the guides.
- **Spare end bobbin:**

The extra ends provided on the warp beam need to be guided through the guides provided on the spare end bar, to the side of the loom and then wound onto the spare end bobbin. These need to be kept tidy otherwise a tangled mess will quickly result. When the bobbin is full it needs to be stripped.
- **Fluff and fly:**

When pieces of fluff or fly have settled on the warp they should be removed immediately to prevent them from being woven in. Fluff and fly attached to machinery should be removed before it becomes detached and also weave into the cloth.
- **Waste / wild yarn:**

Extra piece of yarn, which have either been left on a beam or have dropped onto a loom, remove them immediately before they become entangled or woven in.

## Front of Loom (Cloth Alley)

### 1. Cloth Quality

- **Short picks:**  
Is the weft being inserted properly?
- **Kinks and snarls:**  
Is the weft too lively or not enough tension?
- **Weft bars:**  
Is this a variation of weft; or take-up or left-off motion malfunction?
- **Uneven yarn:**  
Has the weft quality deteriorated and the pirn needs to be changed?
- **Broken pick:**  
Has the weft been inserted for the whole width of the cloth, either breaking in its insertion or not being held at the receiving side?
- **Stitching:**  
This is usually associated with a slack warp end, or too low warp tension.
- **Double end:**  
Two ends weaving as one in the same heald break out the extra end.
- **Wrong draft:**  
An end or ends have been inserted into the wrong heald eye, resulting in a break in the cloth pattern.
- **Wrong dent:**  
An end has been drawn incorrectly in the reed resulting in a warp line down the cloth or a break in the cloth pattern.
- **Selvedge**  
Is the selvedge complete and correct, resulting in a correct edge to the fabric?  
Are the cut-off selvedge being removed correctly? Is the selvedge construction correct?
- **Warp Yarn Guides**  
Are all the catch cord guides clean and in good conditions?
- **Oil**  
Are there any oil marks on the cloth and what has caused them? What need to be done to prevent the problem?
- **Temple Marks**  
Is the cloth passing correctly over the temples? Are any marks being created?
- **Reed Marks**  
Is there any warp way lines caused by a damaged reed dent?
- **Noises**  
Are there any unusual noises, which the fitter needs to investigate?
- **Vibrations**  
Are there any unusual vibrations that the fitter needs to investigate?

## 9. CONTINGENCIES

### Warp related:

- **Extra end:** guide it through the spring to the winding device.
- **Missing end:** take the nearest positioned extra end and guide it through the spring into the missing end position.
- **Crossed end:** to be corrected by the weaver during his patrol.
- **Lap end on warp beam:** it can be an extra end coming up, or a previously missing end coming back.
- **Thick end:** take out, guide to the winding device and replace by a normal end from the reserve.
- **Stuck ends (sizing fault):** separate ends, with the help of the guide spring.
- **Slub (thick place in the yarn):** once spotted it is the weavers responsibility to remove it, to avoid warp breaks (if the slub does not pass the reed), or to avoid a fault (if the slub goes into the cloth).
- **Warp beam cleanliness:** dust and extra ends on the warp beam cause warp breaks. The weaver has to keep the beam clean.
- **Drop wires:** when drop wires are missing or broken they must be replaced. Do not take more than one end through a wire, because the stop motion will no longer work. If there are extra drop wires, take them out or tie them up to avoid false stops.
- **Heald change:** when a heald breaks the weaver has to change it. If there are several healds to change the weaver should call the fitter in order to avoid stopping his patrolling for a long time.
- **Wrong draw in the reed:** the weaver must correct it immediately.

### Weft related:

- **Weft variation between cones:** when weft mixing small variations between cones is hidden. However, if a particular thick or thin yarn is introduced, an irregular appearance will result. The offending cone needs to be replaced and the supervisor informed.

### Machine related:

- **Smash:** when a mechanical function causes a major break, call the fitter. Level the shafts if possible using the levelling device.

### General:

- **Waste/wild yarn:** extra pieces of yarn that have either been left or dropped onto the warp. Remove them immediately before they become woven in. When trimming knots never drop the cut-off ends onto the warp.

## 10. INSTRUCTIONS FOR SHIFT CHANGE

### ➤ Take Charge of the Shift

- Come at least 10 - 15 minutes earlier to the work spot
- Bring the necessary operational tools like "weaver's hook", "knife" etc.
- Meet the previous shift weaver, discuss with him/ her regarding the issues faced by them with respect to the quality or production or spare or safety or any other specific instruction etc.
- Check for the availability of the weft & the condition of the same
- Check the condition of the running beams , for cross ends, ends pulling out particularly at the selvedge
- Check the availability of the " thrums" , quality & condition of the same
- Check the cloth for the running damages like end out, wrong drawing, wrong denting, double end, reed mark, temple cut/ temple mark, let- off mark, take up fault, oil stain, hole, cloth torn, weft catching, weft lashing in etc.
- Check for the size of the cloth rolls & to see whether any indication is there in the cloth rolls
- Check the cleanliness of the machines & other work areas
- Check whether any spare/raw material/ tool / fabric/ any other material are thrown under the machines or in the other work areas.
- Question the previous shift weaver for any deviation in the above and should bring the same to the knowledge of his/ her shift supervisor as well that of the previous shift .

➤ **Handing over the Shift**

- Hand over the shift to the incoming weaver in a proper manner & get clearance from the incoming counterpart before leaving the work spot
- Report to his/ her shift supervisors as well as that of the incoming shift, in case his/ her counterpart doesn't report for the incoming shift. in that case, the shift has to be properly handed over to the incoming shift supervisor & get clearance from him/ her, before leaving the work spot
- Report to his/ her shift supervisor about the quality / production / safety issues/ any other issue faced in his/ her shift and should leave the department only after getting concurrence for the same from his/ her supervisors